



Features :

- Single Set Point
- LED Indications : Relay ON, Seconds, Minutes, Hours
- 3 digits, 7 segment LED, Dual Display

Certification :

Display Specifications

Display	3 digits, 7 segment LED, Dual display Height of Upper Display : 0.3785" Height of Lower Display : 0.2720"
LED Indications	Relay ON, Hr / Min / Sec

Input Specifications

Accuracy	Setting : $\pm 0.05\%$ of set time or 50msec Repeat : $\pm 0.05\%$
Start Input	Gate / Pulse (Programmable)

Output Specifications

Relay Contact	2 C/O SPDT
Contact Rating	5A @ 250V AC

Functional Specifications

Modes	ON delay, Interval, Cyclic ON first, Cyclic OFF first
Time Ranges	0 - 9.99sec 0 - 99.9sec 0 - 999sec 0 - 9:59min : sec 0 - 99.9min 0 - 999min 0 - 9:59hr : min 0 - 99.9hr 0 - 999hr
Resolution	0.01sec
Counting Direction	Down
Set Point	1
Time Setting	By keys on front panel
Reset	Front, Remote, On power interruption (programmable)
Memory Retention	Yes (selectable)
Configuration Lock	Yes

Auxiliary Supply Specifications

Supply Voltage	85 to 270V AC (50 / 60Hz) , 24V AC/DC (Optional) -15% to 10% tolerance
Power Consumption	4VA max

Environmental Specifications

Temperature	Operating : 0 to 50°C (32 to 122°F) Storage : -20 to 75°C (-4 to 167°F)
Humidity (non - condensing)	95% RH

Mechanical Specifications

Mounting	Panel Mount
Weight	XT546 : 142gms XT246 : 180gms XT346 : 240gms

Dimensions

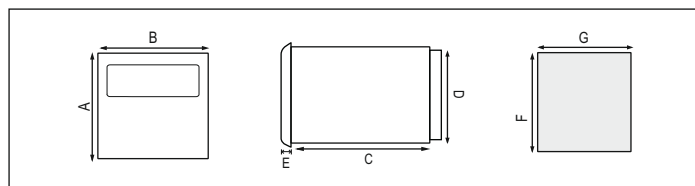

Models	DIM	A	B	C	D	E	F	G
XT546		48	48	94	45	4	46	46
XT246		72	72	83.7	67	10	69	69
XT346		96	96	73	90.5	10	92	92

Terminal Connections

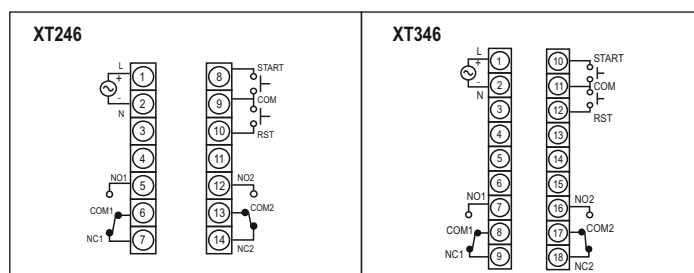
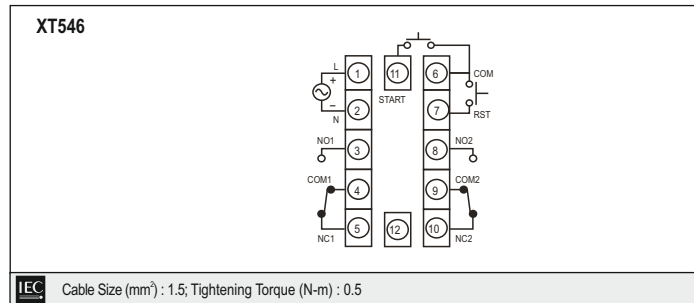

TIMING DIAGRAMS

1. On delay, Interval modes :

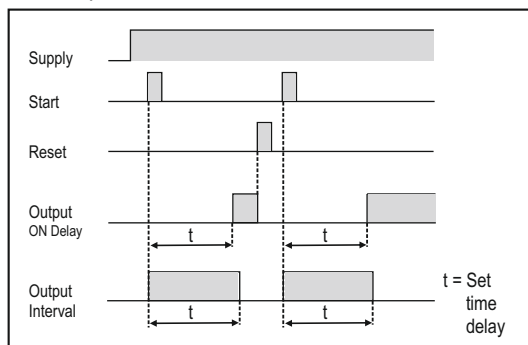

2. Cyclic ON first, Cyclic OFF first modes :

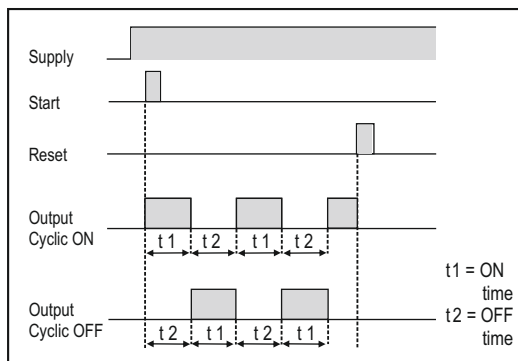

Typical application of Continuous start and reset in On delay mode :

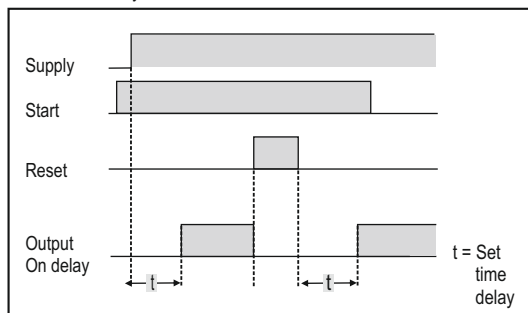

Typical application of Gate start :

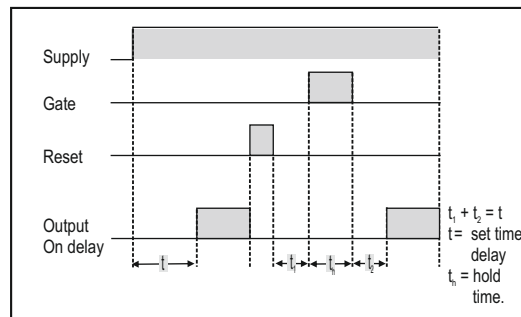

Compliance

Applicable EMI / EMC Standards		
Product Standard		
Category	Reference Standards	Testing Level
Electrostatic Discharge	IEC 61000-4-2	Level-3
Electrical Fast Transient / Burst	IEC 61000-4-4	Level-3
Electromagnetic Field	IEC 61000-4-3	Level-3
Surge	IEC 61000-4-5	Level-3
Conducted RF	IEC 61000-4-6	Level-2
Rated Power Frequency	IEC 61000-4-8	Level-4
Voltage Dip / Short Interruptions	IEC 61000-4-11	Level-3
Conducted Emissions	CISPR-11	Class-B
Rated Emissions	CISPR-22	Class-A
Emission & Immunity	IEC 61326-1	
Safety	IEC 61010-1	
PFMF (Passing criteria)	IEC 61000-4-8	Class A

Ordering Information

Product Code	Supply Voltage	Certification
XT546	85 to 270V AC	---
XT546-CE	85 to 270V AC	CE
XT546-24V	24V AC / DC	---
XT246-24V	24V AC / DC	---
XT246	85 to 270V AC	---
XT346	85 to 270V AC	---