

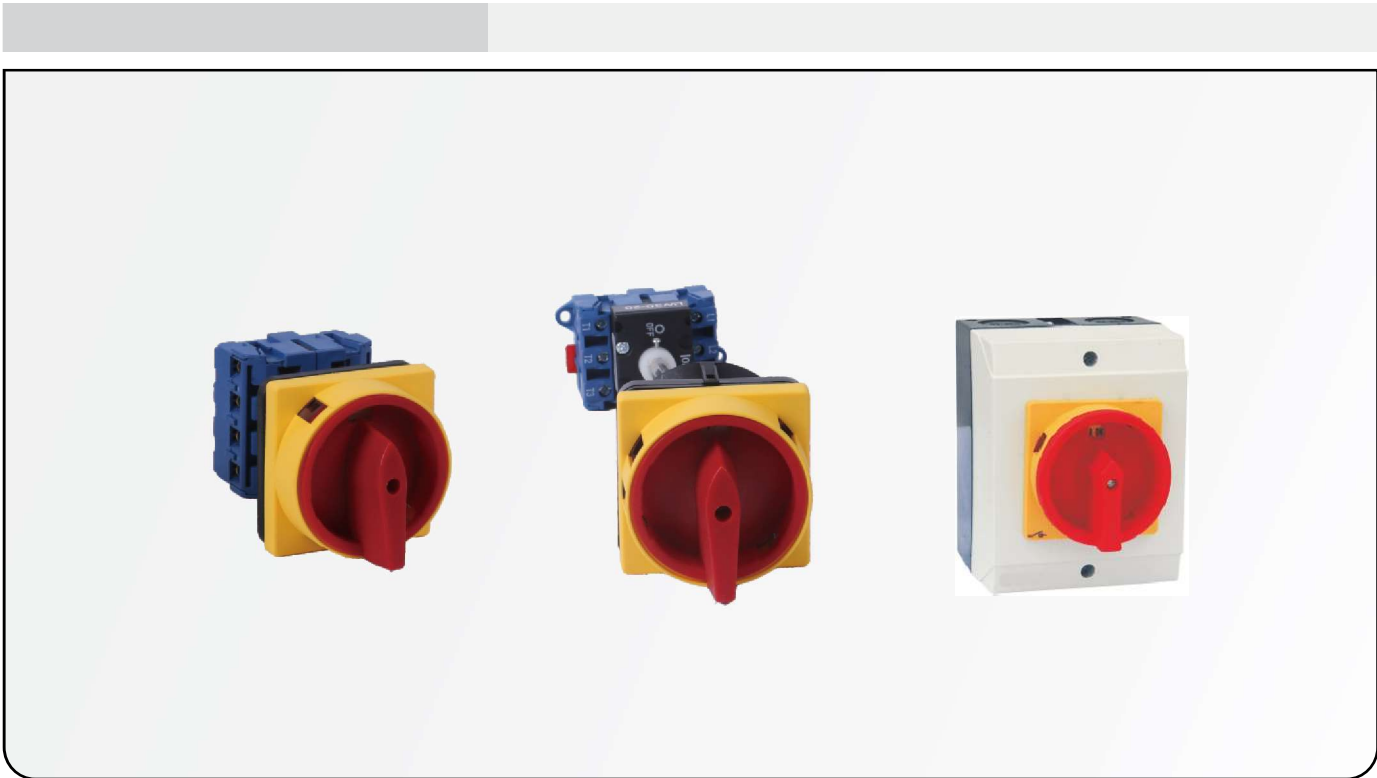



MGLW Series

Rotary switches(MGLW30)

Technical data

Standard	IEC60947-3
Approval	CE
Rated thermal current Ith(A)	20/25/32/40/63/80/100
Rated operational voltage Ue(V)	240/440
Rated insulation voltage Ui(V)	660
Rated frequency(Hz)	50
Number of poles(P)	3,4
Handle type	black thumb grip and light grey front plate padlockable handle
Degree of protection	IP65 with box
Ambient air temperature(°C)	-25~+40 max.90% humidity
Storage temperature(°C)	-40~+75
Maximum operating altitude(meters)	2000



	Function	Number of Poles	In(A)	Type code
	ON/OFF	3	20	MGLW30-3D20
			25	MGLW30-3D25
			32	MGLW30-3D32
			40	MGLW30-3D40
			63	MGLW30-3D63
			80	MGLW30-3D80
	ON/OFF	4	20	MGLW30-3D20
			25	MGLW30-3D25
			32	MGLW30-3D32
			40	MGLW30-3D40
			63	MGLW30-3D63
			80	MGLW30-3D80
	ON/OFF	3	20	MGLW30-3R20
			25	MGLW30-3R25
			32	MGLW30-3R32
			40	MGLW30-3R40
			63	MGLW30-3R63
			80	MGLW30-3R80
	ON/OFF	4	20	MGLW30-3R20
			25	MGLW30-4R25
			32	MGLW30-4R32
			40	MGLW30-4R40
			63	MGLW30-4R63
			80	MGLW30-4R80
	ON/OFF	3	20	MGLW30-3B20
			25	MGLW30-3B25
			32	MGLW30-3B32
			40	MGLW30-3B40
			63	MGLW30-3B63
			80	MGLW30-3B80
	ON/OFF	4	20	MGLW30-4B20
			25	MGLW30-4B25
			32	MGLW30-4B32
			40	MGLW30-4B40
			63	MGLW30-4B63
			80	MGLW30-4B80
			100	MGLW30-4B100

Auxiliary contacts



AC15 220~240V 6A/380~440V 4A

grounding or auxiliary contacts

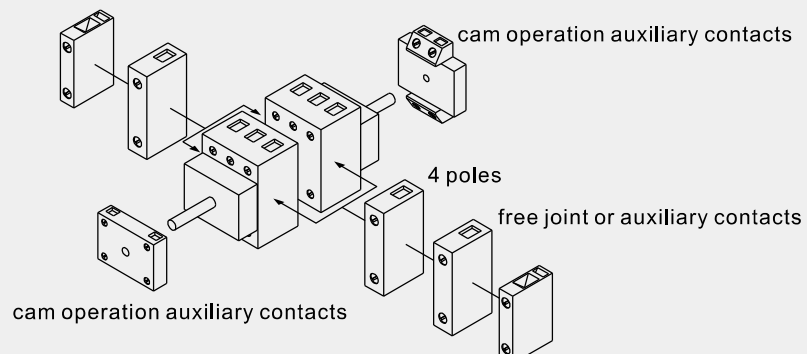

Outline and installation dimensions

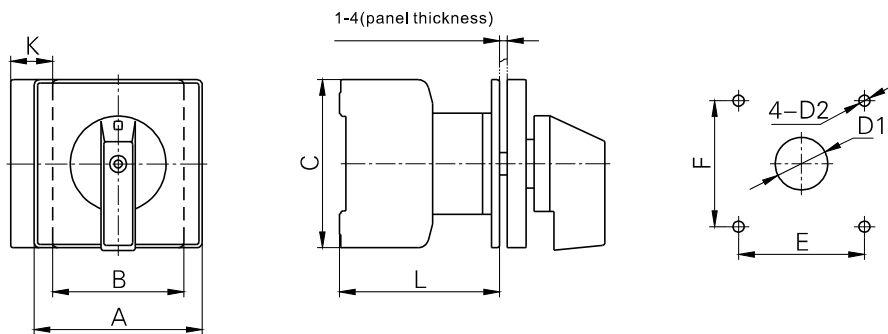

Type	Dimension mm					Mounting Dimension mm			
	A	B	C	L	L	E	F	D1	D2
MGLW30-20	64	42	54	13.5	61	48	48	φ10	φ4.2
MGLW30-25	64	42	54	13.5	61	48	48	φ10	φ4.2
MGLW30-32	64	42	54	13.5	61	48	48	φ10	φ4.2
MGLW30-40	64	50	64	16	67	48	48	φ10	φ4.2
MGLW30-63	64	50	64	16	67	48	48	φ10	φ4.2
MGLW30-80	64	70	80	22.5	82	48	48	φ10	φ4.2
MGLW30-100	64	70	80	22.5	82	48	48	φ10	φ4.2

Type	Dimension mm			Mounting Dimension mm			
	K	Lmin	Lmax	E	F	D1	D2
MGLW30-20	50	32	150	48	48	φ22	φ4.2
MGLW30-25	50	32	150	48	48	φ22	φ4.2
MGLW30-32	50	32	150	48	48	φ22	φ4.2
MGLW30-40	50	32	150	48	48	φ22	φ4.2
MGLW30-63	50	32	150	48	48	φ22	φ4.2
MGLW30-80	50	32	150	48	48	φ22	φ4.2
MGLW30-100	50	32	150	48	48	φ22	φ4.2

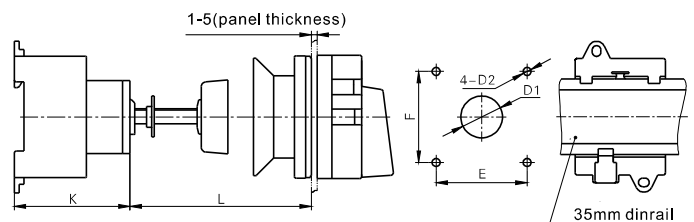

Type	Dimension mm					Mounting Dimension mm			
	D3	D4	M	N	P	A1	A2	B	D2
MGLW30-20	φ23	φ19	85	83	160	150	—	—	φ4.2
MGLW30-25	φ23	φ19	85	83	160	150	—	—	φ4.2
MGLW30-32	φ23	φ19	85	83	160	150	—	—	φ4.2
MGLW30-40	φ29	φ23	100	95	190	178	—	—	φ4.2
MGLW30-63	φ29	φ23	100	95	190	178	—	—	φ4.2
MGLW30-80	φ37.5	φ23	144	145	250	—	229	124	φ4.2
MGLW30-100	φ37.5	φ23	144	145	250	—	229	124	φ4.2

